

# SERIE 4,8mm TERMINALI e CONNETTORI

## .187" Quick Connect Terminals and Connectors

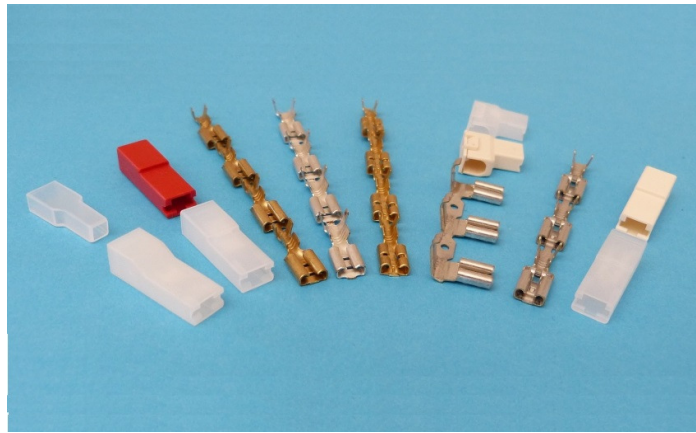

### Descrizione/ Description

Connettori utilizzati per giunzioni singole. I terminali maschi e femmina sono della serie 4,8  
 I connettori sono disponibili anche in materiale UL94-V0 e materiale conforme alla Direttiva IEC 60335-1 con GWT a 750°C . Tutti i materiali sono conformi alla direttiva RoHS.

Connectors used for single and multiple connections , the receptacles are available for 4.8 mm (.187 Series) 0.5 and 0.8 thick tabs. IEC 60335-1, Glow Wire 750° No Flame housings available , RoHS Compliant

### Identificazione Connettori / Connectors identification

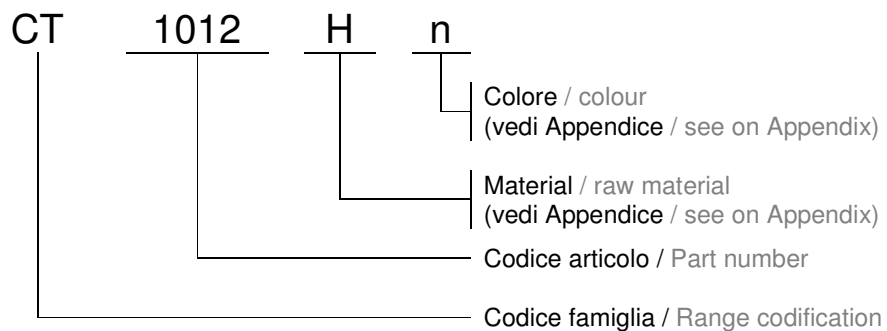

### Materiali e Finiture / Materials and Platings

Connettori / Housings : PA66 UL94V2 , UL94V0 and GWT 750°C Noflame

# SERIE 4,8mm TERMINALI e CONNETTORI

## .187" Quick Connect Terminals and Connectors

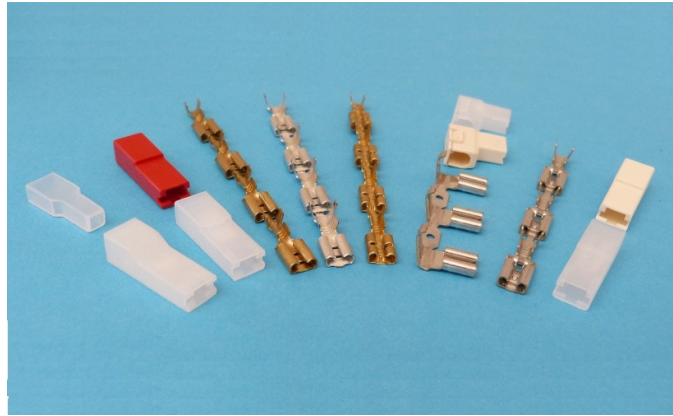

### Descrizione/ Description

Connettori utilizzati per giunzioni singole. I terminali maschi e femmina sono della serie 4,8  
 I connettori sono disponibili anche in materiale UL94-V0 e materiale conforme alla Direttiva IEC 60335-1 con GWT a 750°C . Tutti i materiali sono conformi alla direttiva RoHS.  
 Connectors used for single and multiple connections , the receptacles are available for 4.8 mm (.187 Series) 0.5 and 0.8 thick tabs. IEC 60335-1, Glow Wire 750° No Flame housings available , RoHS Compliant

### Identificazione Terminali/ identification

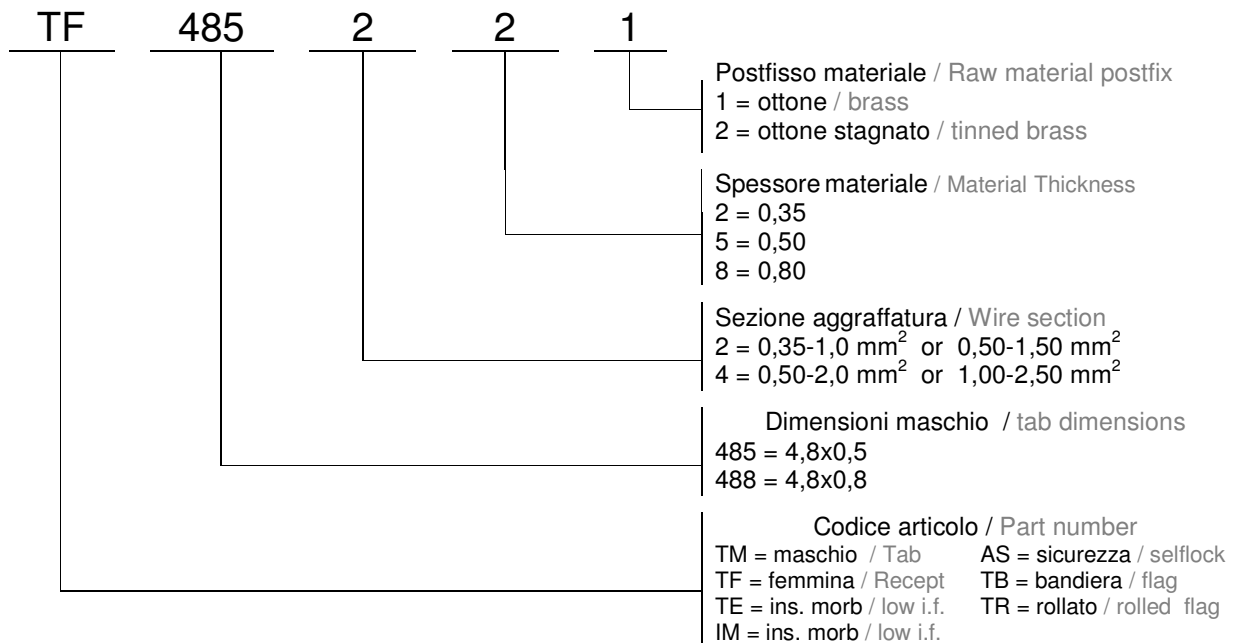

### Materiali e Finiture / Materials and Platings

Terminali / Terminals : Ottone , Ottone Stagnato / Brass, Tin plated Brass

### Caratteristiche Elettriche / Electrical Performances

Tensione di lavoro - Voltage Rating : 250V AC/DC  
 Portata di corrente - Current Rating : fino a / up to 16 Amp (DIN 46249 Teil1)  
 Resistenza della connessione / Connection Resistance : 3 - 35 mΩ (DIN 46249 Teil1)  
 Sezione di aggraffatura - Applicable Wire : 0,35 - 2,5mm<sup>2</sup> (DIN 46249 Teil1)

# SERIE 4,8mm TERMINALI e CONNETTORI

## .187" Quick Connect Terminals and Connectors

### TERMINALE FEMMINA QUICK-CONNECT RECEPTACLE

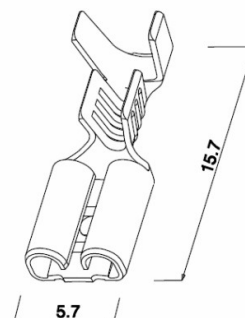
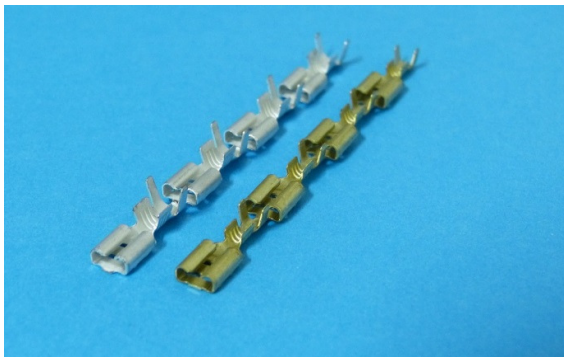

CODICE Code	SEZIONE CAVO Wire size		MATERIALE Material	TRATTAMENTO Treatment	CONFEZIONE Package	OMOLOGAZ. Approval
	mm <sup>2</sup>	AWG				
<b>4,8x0,5</b>						
TF485221	0,35-1	22-17	Ottone / Brass	---	3 x 10.000	UL
TF485222	0,35-1	22-17	Ottone / Brass	Stagnato / Tin plated	3 x 10.000	UL
TF485225	0,35-1	22-17	Acciaio / Steel	Nichelato / Nickeled	2 x 10.000	---
TF485421	0,5-2	20-14	Ottone / Brass	---	3 x 10.000	UL
TF485422	0,5-2	20-14	Ottone / Brass	Stagnato / Tin plated	3 x 10.000	UL
TF485425	0,5-2	20-14	Acciaio / Steel	Nichelato / Nickeled	2 x 10.000	---
<b>4,8x0,8</b>						
TF488221	0,35-1	22-17	Ottone / Brass	---	3 x 10.000	UL
TF488222	0,35-1	22-17	Ottone / Brass	Stagnato / Tin plated	3 x 10.000	UL
TF488225	0,35-1	22-17	Acciaio / Steel	Nichelato / Nickeled	2 x 10.000	---
TF488421	0,5-2	20-14	Ottone / Brass	---	3 x 10.000	UL
TF488422	0,5-2	20-14	Ottone / Brass	Stagnato / Tin plated	3 x 10.000	UL
TF488425	0,5-2	20-14	Acciaio / Steel	Nichelato / Nickeled	2 x 10.000	---

# SERIE 4,8mm TERMINALI e CONNETTORI

## .187" Quick Connect Terminals and Connectors

### COPRITERMINALE FEMMINA

#### FEMALE CONNECTOR

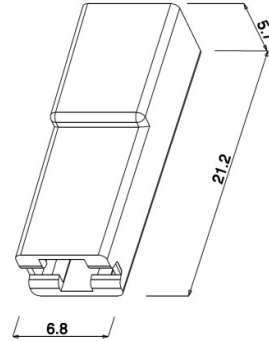
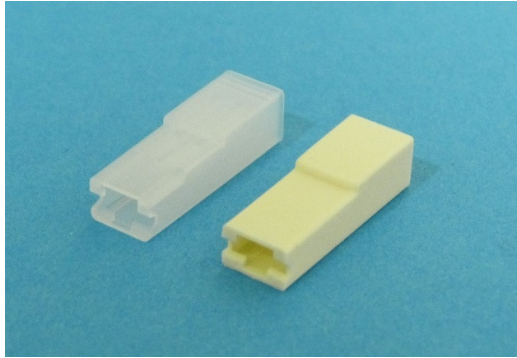

CODICE Code	CONFEZIONE Package	COLORE Colour	MATERIALE Material	UL94	Note
CT1012	25.000	Neutro /Neutral	Nylon 66	UL94-V2	RTI 105
CT1012-1	25.000	Nero /Black	Nylon 66	UL94-V2	RTI 105
CT1012V0	25.000	Neutro /Neutral	Nylon 6-66	UL94-V0	RTI 140
CT1012H	25.000	Neutro /Neutral	Nylon 66	UL94-V2	GWT
CT1012Z	25.000	Neutro /Neutral	Nylon 66	UL94-V0	GWT

### COPRITERMINALE FEMMINA

#### FEMALE CONNECTOR

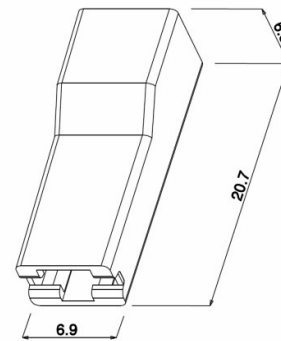

CODICE Code	CONFEZIONE Package	COLORE Colour	MATERIALE Material	UL94	Note
CT1012D	25.000	Neutro /Neutral	Nylon 66	UL94-V2	RTI 105
CT1012DV0	25.000	Neutro /Neutral	Nylon 6-66	UL94-V0	RTI 140
CT1012DH	25.000	Neutro /Neutral	Nylon 66	UL94-V2	GWT
CT1012DZ	25.000	Neutro /Neutral	Nylon 66	UL94-V0	GWT

# SERIE 4,8mm TERMINALI e CONNETTORI

## .187" Quick Connect Terminals and Connectors

### COPRITERMINALE AD INSERIMENTO POSTERIORE BACK INSERTION CONNECTOR

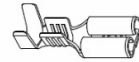
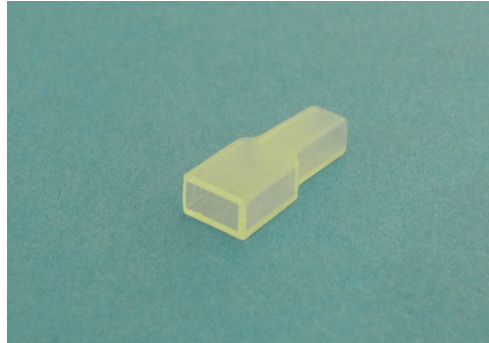

4,8 x 0,5  
4,8 x 0,8

CODICE Code	CONFEZIONE Package	COLORE Colour	MATERIALE Material	INFIAMMABILITA' Flammability	
<b>CT1012PE</b>	30.000	Neutro /Neutral	PE	UL94-V2	--
<b>CT1012PE1</b>	30.000	Nero / Black	PE	UL94-V2	--

# SERIE 4,8mm TERMINALI e CONNETTORI

## .187" Quick Connect Terminals and Connectors

### TERMINALE DI SICUREZZA SELF LOCKING RECEPTACLE

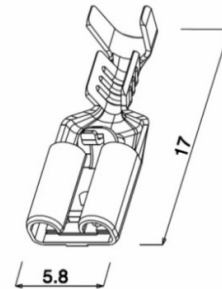
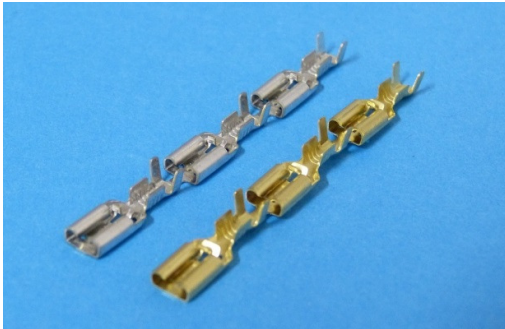

CODICE Code	SEZIONE CAVO Wire size		MATERIALE Material	TRATTAMENTO Treatment	CONFEZIONE Package	OMOLOGAZ. Approval
	mm <sup>2</sup>	AWG				
<b>4,8x0,5</b>						
AS485221	0,5-1,5	20-15	Ottone / Brass	---	3 x 10.000	
AS485222	0,5-1,5	20-15	Ottone / Brass	Stagnato / Tin plated	3 x 10.000	
AS485421	1,0-2,5	17-13	Ottone / Brass	---	3 x 10.000	
AS485422	1,0-2,5	17-13	Ottone / Brass	Stagnato / Tin plated	3 x 10.000	
<b>4,8x0,8</b>						
AS488221	0,5-1,5	20-15	Ottone / Brass	---	3 x 10.000	
AS488222	0,5-1,5	20-15	Ottone / Brass	Stagnato / Tin plated	3 x 10.000	
AS488421	1,0-2,5	17-13	Ottone / Brass	---	3 x 10.000	
AS488422	1,0-2,5	17-13	Ottone / Brass	Stagnato / Tin plated	3 x 10.000	

### COPRITERMINALE DI SICUREZZA SELF-LOCKING CONNECTOR

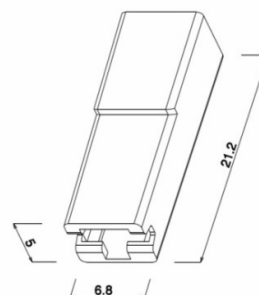
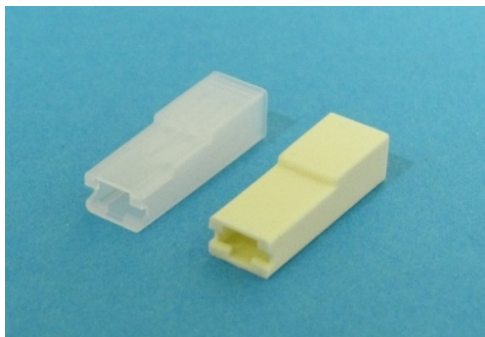

CODICE Code	CONFEZIONE Package	COLORE Colour	MATERIALE Material	UL94	Note
CT1013	25.000	Neutro /Neutral	Nylon 66	UL94-V2	RTI 105
CT1013V0	25.000	Neutro /Neutral	Nylon 6-66	UL94-V0	RTI 140
CT1013H	25.000	Neutro /Neutral	Nylon 66	UL94-V2	GWT
CT1013Z	25.000	Neutro /Neutral	Nylon 66	UL94-V0	GWT

# SERIE 4,8mm TERMINALI e CONNETTORI

## .187" Quick Connect Terminals and Connectors

### TERMINALE FEMMINA ROLLATO

#### ROLLED FLAG RECEPTACLE

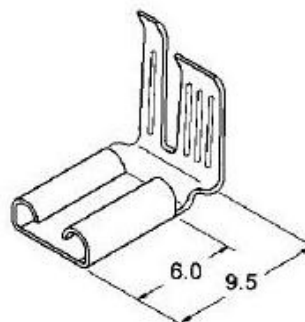

CODICE Code	SEZIONE CAVO Wire size		MATERIALE Material	TRATTAMENTO Treatment	CONFEZ.NE Package	OMOLOGAZ. Approval
	mm <sup>2</sup>	AWG				
<b>4,8x0,5</b>						
TR485221	0,5-1,5	20-17	Ottone / Brass	---	24.000	UL
TR485222	0,5-1,5	20-17	Ottone / Brass	Pre stagnato/PreTinned	24.000	UL
<b>4,8x0,8</b>						
TR488221	0,5-1,5	20-17	Ottone / Brass	---	24.000	UL
TR488222	0,5-1,5	20-17	Ottone / Brass	Pre stagnato/PreTinned	24.000	UL

### COPRITERMINALE FEMMINA ROLLATO

#### SHORT FLAG CONNECTOR

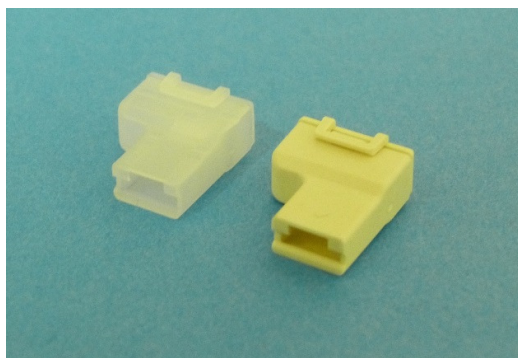

CODICE Code	CONFEZIONE Package	COLORE Colour	MATERIALE Material	UL94	Note
CT1009D	25.000	Neutro /Neutral	Nylon 66	UL94-V2	RTI 105
CT1009D1	25.000	Nero /Black	Nylon 66	UL94-V2	RTI 105
CT1009DV0	25.000	Neutro /Neutral	Nylon 6-66	UL94-V0	RTI 140
CT1009DH	25.000	Neutro /Neutral	Nylon 66	UL94-V2	GWT
CT1009DZ	25.000	Neutro /Neutral	Nylon 66	UL94-V0	GWT